



TX3500S

Compact 5 watt UHF CB radio



ScanSuite™



Full Spectrum
Backlighting



Clear Sound
DSP



Advanced Signal
Management



Dynamic Volume
Control



Front and Rear
Mic Input



INSTRUCTION MANUAL

CONTENTS

ACCESSORIES SUPPLIED.....	2	Receive (RX) only Channels	16
INTRODUCTION	2	Configuration Menu.....	16
IMPORTANT INFORMATION.....	3	INSTALLATION	18
Possible Issues	3	DC Power Connection	20
Emergency Channels.....	3	High Voltage Warning	20
Telemetry Channels.....	3	ANTENNA CONNECTION.....	21
FEATURES	4	NOISE SUPPRESSION.....	21
CONTROLS.....	5	CTCSS TONE FREQUENCY CHART	22
Front Panel Controls.....	5	DCS TONE CHART.....	23
Rear Panel	5	UHF CB OPERATING FREQUENCIES	24
LCD Panel.....	5	SPECIFICATIONS	25
TX3500S microphone.....	5	SC CONTRACT WARRANTY AGAINST DEFECTS	27
GENERAL OPERATION.....	6		
Volume.....	6		
Selecting Channels.....	6		
Squelch	6		
Signal Meter	6		
Transmitting.....	6		
Time-out Timer	6		
Backlighting.....	7		
Beep Tone volume.....	7		
Bandwidth Filter Settings	7		
Dynamic Volume Control (DVC)	8		
Silent Squelch Tail	8		
Repeaters and Duplex Mode	8		
Priority Channel	10		
Scanning	10		
Open Scan.....	10		
Group Scan.....	11		
Network Scan	12		
CTCSS & DCS.....	14		

ACCESSORIES SUPPLIED

- TX3500S Radio
- DC Lead
- Mounting Cradle
- Screw Pack
- Microphone
- Instruction Manual
- Microphone Clip

INTRODUCTION

Your GME TX3500S 80 channel radio is Australian designed and built and is the most advanced UHF Citizen Band radio available.

The TX3500S combines the very latest in electronic hardware with the most up-to-date computer aided design and manufacturing techniques to produce an extremely compact mobile radio with outstanding specifications and performance.

The TX3500S is designed for unobtrusive mounting in modern vehicles. With its built-in loud speaker and extremely small size the TX3500S can be mounted in almost any convenient location.

IMPORTANT INFORMATION

The use of the Citizen Band radio service is licensed in Australia by the ACMA Radio communications (Citizens Band Radio Stations) Class Licence and in New Zealand by the Ministry of Economic Development New Zealand (MED). A General User Radio Licence for Citizens Band radio and operation is subject to conditions contained in those licences.

The class licence for users and equipment operating in the CB/PRS 477 MHz band has been amended. This radio meets the new 80 channel standard.

In simple terms the same amount of spectrum is available; however, radio transceivers can now operate in a narrower bandwidth and hence use less spectrum. These radios are generally referred to as narrowband or 12.5 kHz radios. By using 12.5 kHz channel spacing instead of 25 kHz, the 40 channels originally allocated can now be expanded to 80 channels thereby doubling the channel capacity and relieving congestion in the UHF CB/PRS band.

Original 40 channel wideband Radios will continue to operate on the original 40 channels, however they will not be able to converse on the newer channels 41 – 80. The newer narrowband radios will be able to converse with all older 40 channel wideband radios on all channels 1 to 40 as well as the newer channels allocated from 41 to 80. The mixing of narrowband and wideband radios in the same spectrum can cause some possible operating issues of interference and varying levels of received volume.

POSSIBLE ISSUES

The mixing of narrowband and wideband radios in the same spectrum can cause some possible operating issues of interference and differences in levels of received volume. When a new narrowband radio receives a transmission from an older wideband radio the speech may sound loud and distorted – simply adjust your radio volume for best performance.

When an older wideband radio receives a signal from a new narrowband radio, the speech may sound quiet – simply adjust your radio volume for best performance.

Depending on how close your receiving radio is to another transmitting radio, there can be interference from the transmitting radio if it is using a channel adjacent to the channel you are listening to. Simply try moving up or down a few channels from the currently selected channel.

The above situations are not a fault of the radio but a normal symptom of operating wideband and narrowband radios in the same bandwidth. This possible interference will decrease over time as the population of wideband radios operating in the UHF CB band ages and decreases.

Further information and updates are available from the Australian Communications and Media Authority (ACMA) at www.acma.gov.au and the Ministry of Economic Development (MED) Radio Spectrum Management at: www.rsm.govt.nz

EMERGENCY CHANNELS

The ACMA has allocated channels 5/35 for emergency use only. Channel 5 is the primary Simplex Emergency Channel. Where a Channel 5 repeater is available, you should select Duplex on CH 5.

NOTE: Channel 35 is the input channel for the Channel 5 repeater therefore Channel 35 should also not be used for anything other than emergency transmissions.

TELEMETRY CHANNELS

ACMA regulations have allocated channels 22 and 23 for telemetry only applications and have prohibited the transmission of speech on these channels. Consequently the TX3500S has a transmit inhibit applied to channels 22 and 23. In the event additional telemetry/telecommand channels are approved by the ACMA, these channels shall be added to those currently listed where voice transmission is inhibited. Currently transmissions on channels 61, 62 and 63 are also inhibited and these channels are reserved for future allocation.

FEATURES

TRANSMIT (TX)

Individually Programmable DUPLEX function: User selectable for only those individual channels in your area that have repeaters, leaving the others free for use as extra simplex channels.

SCANNING AND MEMORY FUNCTIONS

Microprocessor Controlled Frequency Synthesiser: Allows user programmable control of scanning, channel memories and selected feature options.

Programmable Scan Function: Scans the selected UHF CB channels with both Group, Open and Network scan functions available.

Priority Channel: A user programmable Priority channel feature allows your working channel to be instantly recalled at the press of a key.

SIGNAL PROCESSING

Digital Signal Processing: Measures, filters and compresses standard analogue audio signals and converts them into digital format. Allows advanced RF and audio processing techniques to be applied to maximise the radios performance.

Advanced Signal Management: Identifies interference caused by strong local signals on adjacent channels and prevents these from opening your Squelch. ASM also minimises distortion on reception by fine tuning the receiver frequency to match that of the incoming signal.

Dynamic Volume Control: Automatically compensates for variations in received audio level to provide a constant audio output level to the speaker.

PRIVACY FUNCTIONS

CTCSS & DCS: A built-in Continuous Tone Coded Squelch and Digital Coded Squelch System option provides silent channel operation.

PHYSICAL PROPERTIES

Over Voltage Protection: Special overvoltage detection circuitry protects the radio and warns of excessive voltage conditions by flashing the display.

USER CONTROLS AND INTERFACE

Full Spectrum Backlighting: User adjustable, totally customisable backlight settings to match the vehicles dashboard lighting or drivers preference.

High Contrast Liquid Crystal Display: Fully detailed LCD provides a visual indication of the selected channel and all selected functions at a glance.

Front and Rear Microphone Inputs: Convenient front and rear microphone inputs to facilitate ease of installation and operation across a range of vehicles.

CONTROLS

FRONT PANEL CONTROLS

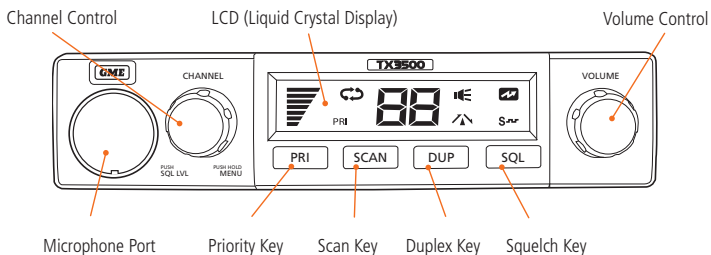

REAR PANEL

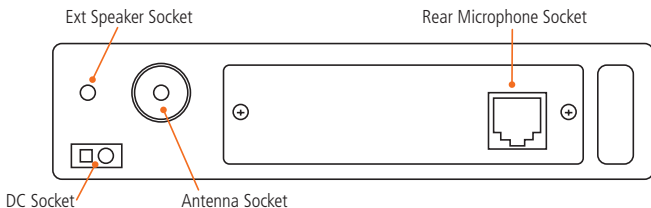

LCD PANEL

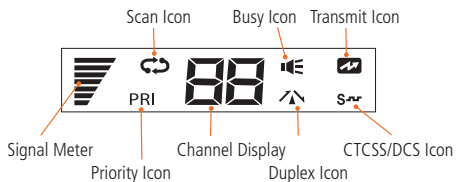

TX3500S MICROPHONE

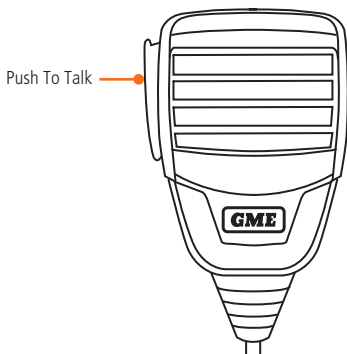

GENERAL OPERATION

VOLUME

Rotate the **Volume** control clockwise past the 'click' to turn the TX3500S on. Rotate the control further clockwise to increase the volume, or counter clockwise to decrease the volume.

If no sound is heard, briefly press the **SQL** key to temporarily un-mute the radio then adjust the volume while listening to the background noise. When finished, briefly press the **SQL** key again to re-mute the radio.

NOTE: At the minimum volume setting there is still sufficient volume to be heard in a quiet cabin environment.

SELECTING CHANNELS

Select the required channel by rotating the **Channel** Control. Rotate the knob clockwise to select higher channel and counter clockwise to select lower channels. The selected channel is displayed on the LCD.

SQUELCH

The Squelch is used to eliminate any annoying background noise when there are no signals present. The Squelch can be opened or closed using the **SQL** key. When the Squelch is open the receiver's background noise can be heard and the  symbol is displayed. When the Squelch is closed the receiver remains quiet while there are no signals present but any incoming signals will override the Squelch and be heard in the speaker.

To open the Squelch

Briefly press the **SQL** key. A low beep will be heard and the  symbol will be displayed. If there are no signals present you will hear the receiver's background noise.

To close the Squelch

Briefly press the **SQL** key. A high beep will be heard. If there are no signals present the  symbol will disappear and the receiver will become quiet again.

Adjusting the Squelch level



The TX3500S's default Squelch sensitivity level has been factory set to provide optimum performance under most operating conditions. If required, the sensitivity level can be adjusted to suit changing conditions.



To adjust the Squelch sensitivity, briefly press the **Channel** Control. The channel display will show the current Squelch setting in values from 1 – 9. A Squelch setting of –1 allows the Squelch to open on very weak signals whereas a setting of –9 requires much stronger signals to overcome the Squelch. Rotate the **Channel** Control to change the Squelch setting. Press the **Channel** Control to accept the setting and return to normal operation.

SIGNAL METER

The signal meter  indicates the relative signal strength of the incoming signal. Stronger incoming signals will display more bars while weaker signals will display less bars.

TRANSMITTING

Prior to transmitting, always check the channel is not being used. This can be done either by listening or by checking that the signal meter  and the 'BUSY' icon  is not visible.

To transmit, press the **PTT** on the microphone. The  icon will appear. Hold the microphone about 5-8 cm from your face and speak at a normal voice level. The microphone is quite sensitive so it is not necessary to raise your voice or shout. Release the **PTT** when you have finished talking. The  icon will disappear.

IMPORTANT: Always listen to ensure the channel is free before transmitting.

TIME-OUT TIMER

Your TX3500S has an in-built Time-Out Timer (TOT) that limits transmissions to a maximum of 3 minutes of continuous operation. This feature is required by the ACMA to prevent the radio from jamming the frequency if the **PTT** has been accidentally jammed. Once the TOT is triggered the radio will beep once and the transmitter output will be switched off. If the **PTT** remains pressed, the transmit icon  will remain visible but there will be no signal transmitted

from the radio. Once the **PTT** has been released the **TOT** is reset and transmissions can recommence.

BACKLIGHTING

The Liquid Crystal Display and keys are backlit for easy viewing at night. The backlighting remains on at while the TX3500S is switched ON.

Adjusting the backlighting

The backlighting brightness and colour can be adjusted for personal preference. There are three settings available;

'br' - **Brightness Setting:** Provides a continuously variable brightness adjustment from very dim to full brightness.

'cl' - **Colour Setting:** Provides a continuously variable colour change via a smooth blend of Red, Green and Blue colours.

'li' - **Lightness Setting:** Provides a continuously variable lightness or colour saturation of the selected colour from full colour to white (no colour).

To make adjustments to the backlighting,

1. Press and hold the **Channel** Control to enter the Menu. 'br' will be displayed indicating the Brightness mode is selected.
2. Rotate the **Channel** Control to adjust the display brightness.
3. Briefly press the **Channel** Control to select the Colour mode. 'cl' will be displayed.
4. Rotate the **Channel** Control to adjust the colour.
5. Briefly press the **Channel** Control to select the Lightness mode. 'li' will be displayed.
6. Rotate the **Channel** Control to adjust the lightness (saturation) of the chosen colour. For the deepest colour range, reduce the lightness setting.

When finished, press and hold the **Channel** Control to return to normal operation.

NOTE: The Menu function will automatically time out after 6 seconds if no further adjustments have been made.

BEEP TONE VOLUME

The Key Beeps provide audible feedback whenever the keys are pressed. You can adjust the volume of the key beeps as follows.

1. Press and hold the **Channel** Control to enter the Menu. 'br' will be displayed.
2. Press the **Channel** Control repeatedly until 'bP' (Beep) is displayed.
3. Rotate the **Channel** Control clockwise to increase the Beep volume or counter-clockwise to decrease the Beep volume. The signal meter bars will increase or decrease with the volume level setting.

When finished, press and hold the **Channel** Control to return to normal operation.

BANDWIDTH FILTER SETTINGS

The TX3500S is fitted with two user-selectable receiver bandwidth filters which allow the receiver to be adjusted for either wide or narrow band reception on channels 1 – 40. This feature provides additional compatibility with older 40-channel radios. The wide setting increases the tolerance of the TX3500S receiver to older wideband 40 channel radios or to signals that might be slightly off frequency. The narrow setting increases the selectivity of the receiver to help reduce interference from strong interfering signals on adjacent channels.

To change the filter setting

1. Press and hold the **Channel** Control to enter the Menu. 'br' will be displayed.
2. Press the **Channel** Control repeatedly until 'FL' (Filter) is displayed.
3. Rotate the **Channel** Control clockwise to select the Narrow Band Filter. The close spacing of the signal meter bars confirms the Narrow Band Filter is selected.



4. Rotate the **Channel** Control to select the Wide Band Filter. The wide spacing of the signal meter bars confirms the Wide Band Filter is selected.



When finished, press and hold the **Channel** Control to return to normal operation.

NOTE: The wideband filter selection only operates on channels 1-40. Channels 41-80 always remains narrowband.

DYNAMIC VOLUME CONTROL (DVC)

The modulation level of signals heard on the UHF CB band has always varied considerably resulting in noticeable differences in received audio volume between stations. Generally users have compensated for this by adjusting the volume control for each received signal. With the introduction of 80 channel narrowband transmissions that use lower levels of modulation, the diversity in received audio volume is likely to increase further.

The TX3500S is able to automatically compensate for these variations in received audio level by utilising a Dynamic Volume Control. When activated, this feature automatically compensates for variations in received audio level resulting in a constant audio output level to the speaker to greatly enhance the quality of the reception.

To switch the Dynamic Volume Control ON or OFF

1. Press and hold the **Channel** Control to enter the Menu. 'br' will be displayed.
2. Press the **Channel** Control repeatedly until 'dL' (Dynamic Level) is displayed.
3. Rotate the **Channel** Control clockwise one click to view the current setting.
4. Rotate the **Channel** Control clockwise again to select ON. 'on' is displayed.
5. Rotate the **Channel** Control counter-clockwise to select OFF. 'oF' is displayed.

When finished, press and hold the **Channel** Control to return to normal operation.

SILENT SQUELCH TAIL

The Squelch Tail is the short burst of noise that is heard in the speaker at the end of a transmission before the Squelch closes.

To some it is a reassuring confirmation that it is their turn to transmit but in some applications it may be an annoyance especially when listening through an earpiece or headphones.

The Silent Squelch Tail function removes this Squelch Tail, reducing it to a faint click as the Squelch closes.

To enable or disable the Silent Squelch Tail

1. Press and hold the **Channel** Control to enter the Menu. 'br' will be displayed.
2. Press the **Channel** Control repeatedly until 'St' (Silent Tail) is displayed.
3. Rotate the **Channel** Control one click. The current setting is displayed.
4. Rotate the **Channel** Control to the right to enable the Silent Squelch Tail. 'on' will be displayed and the Squelch Tail will be silent.
5. Rotate the **Channel** Control to the left to disable the Silent Squelch Tail. 'oF' will be displayed and the Squelch Tail will be restored.

When finished, press and hold the **Channel** Control to return to normal operation.

REPEATERS AND DUPLEX MODE

Duplex operation allows the radio to transmit on a different frequency to that which it receives. This allows operation through repeater stations.

A repeater station consists of a linked transmitter/receiver combination installed in a prominent location. The repeater is designed to receive signals on a designated channel and

retransmit them on another channel. Repeaters are usually mounted on hills or tall buildings. The increased elevation greatly improves both the receiving and transmitting range of the repeater allowing it to receive and retransmit signals to radios that would otherwise be out of range of each other.

Normally, UHF radios transmit and receive on the same frequency - known as Simplex operation. However to communicate through repeaters, your radio must be able to transmit and receive on different channels – otherwise known as Duplex operation. Your TX3500S is fitted with a Duplex key to allow you to operate through repeaters.

The Duplex function can only be selected on channels 1-8 and 41-48 as these are the channels that have been allocated for repeater use. When Duplex is selected, your TX3500S receives on the selected channel (e.g. CH 1) but transmits 30 channels higher (CH 31). The repeater hears your signal on CH 31 and retransmits it on CH 1 for others to hear.

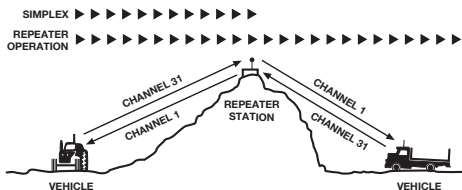



The TX3500S allows you to enable or disable Duplex mode on individual repeater channels. In this way any repeater channels that are not being used with repeaters in your area can be used in Simplex mode for normal direct radio-to-radio communications.

To enable Duplex on a repeater channel

1. Select the required repeater channel (1–8, 41–48)
2. Briefly press the **DUP** key. The duplex symbol  will appear on the display accompanied by a high beep.

To remove Duplex from a repeater channel

1. Select the required repeater channel (1-8, 41-48). If duplex is currently selected, the  duplex symbol will appear.
2. Briefly press the **DUP** key. The duplex symbol  will disappear from the display accompanied by a low beep.

Channel Selected	Receive Channel	Transmit Channel
1	1	31
2	2	32
3	3	33
4	4	34
5*	5*	35*
6	6	36
7	7	37
8	8	38
41	41	71
42	42	72
43	43	73
44	44	74
45	45	75
46	46	76
47	47	77
48	48	78

* Emergency channel only

PRIORITY CHANNEL

The Priority channel feature allows you to instantly recall any one of the 80 channels in the TX3500S. This feature can be used to provide instant access to your working channel or your local repeater channel at the press of key. It is also used in conjunction with the Group Scan mode.

To store a Priority channel

1. Select the required channel.
2. Press and hold the **PRI** key. The channel number will flash then a high beep will be heard as the channel is stored.

To recall a Priority channel

1. Briefly press the **PRI** key.
2. The TX3500S will immediately switch to the Priority channel and the 'PRI' icon will be displayed.
3. To return to the previously selected channel press the **PRI** key again. The 'PRI' icon will disappear and the radio will return to the previously selected channel.

SCANNING

The TX3500S incorporates a Scan function allowing selected groups of channels to be scanned for signals. Channels can be scanned at a rate of 40 channels per second. When a signal is found, scanning will pause to allow the signal to be heard then resume scanning when the channel is clear again.

Scan groups

The TX3500S features three scan groups - Open Scan, Group Scan and Network Scan. Each scan group has a separate channel memory allowing you to program your choice of channels into each group for scanning.

To select Open Scan, Group Scan or Network Scan

1. Press and hold the **Channel** Control to enter the Menu. 'br' will be displayed.
2. Press the **Channel** Control repeatedly until 'Sc' (Scan) is displayed.
3. Rotate the **Channel** Control to select 'oS' (Open Scan), 'GS' (Group Scan) or 'nS' (Network Scan).

When finished, press and hold the **Channel** Control to return to normal operation.

NOTE: Network Scan is disabled by default and will not appear in the Scan Group menu unless it has been enabled. See Network Scan (on page 12) for details on how to enable and use Network Scan.

Auto Skip

While scanning, if an active channel in your Scan Group becomes a nuisance by constantly interrupting the scan, briefly rotate the **Channel** Control while the radio is paused on that channel. The busy channel will be temporarily removed from the scan group to allow time for the channel to become clear again and scanning will continue from the next channel in the sequence. After 30 seconds the skipped channel will be reinstated in the scan sequence.

If the unwanted active channel continues to interrupt the scan even after the 30 second skip period has elapsed, hold the **SCAN** key while the radio is paused on that channel. The 'nuisance' channel will be completely removed from the scan group for the duration of that scan session. To restore the channel, simply stop and restart the scan session using the **SCAN** key (or switch the radio Off then On again).

NOTE: You can skip as many busy channels from the scan group as you wish, however if you attempt to skip the last remaining channel, all the previously skipped channels will be restored to the scan group.

OPEN SCAN

Open Scan allows a group of channels to be scanned in an ascending sequence. If a signal is found, the scan will pause on that channel. During this time you can press the **PTT** on the microphone and talk on the channel. Once the channel has been clear for 5 seconds the scan will resume.



Example: Scanning channels 1 – 8 in Open Scan

Selecting Open Scan





1. Press and hold the **Channel** Control to enter the Menu. 'br' will be displayed.
2. Press the **Channel** Control repeatedly until 'Sc' (Scan) is displayed.
3. Rotate the **Channel** Control to select 'oS' (Open Scan).

When finished, press and hold the **Channel** Control to return to normal operation.

Programming the Scan Memory

Your radio has all 80 channels factory-programmed into the Open Scan memory. Any channels not required can be removed.

To add or remove channels from the Open Scan memory:

1. Select the required channel using the **Channel** Control.
2. Check to see if the scan symbol  is displayed on that channel.
 - If  is displayed, the selected channel is already in the scan memory. Press and hold the **SCAN** key to remove it.  will disappear.
 - If  is not displayed, the selected channel is not in the scan memory. Press and hold the **SCAN** key to add the selected channel to the scan memory.  will now be displayed on that channel.

Repeat to add or remove other channels in the scan memory.

Default working channel in Open Scan mode

In the Open Scan mode, your default working channel is the channel your radio switches to when you press the **PTT** while scanning. To define your working channel simply select the required channel before you press the **SCAN** key. e.g. to make channel 24 your working channel, simply select channel 24 before pressing the **SCAN** key.

To begin scanning

Briefly press the **SCAN** key. A high beep will be heard and the  icon will animate. During this time the channel numbers will change rapidly as the channels are scanned.

NOTE: If there are less than 2 channels programmed into the Open Scan memory, a long low beep will be heard when you press the **SCAN** key and the command will be ignored.

Operating in the Open Scan mode

If a busy channel is found, scanning will pause to allow the signal to be heard and will remain there for as long as the channel remains busy. Once the channel has been clear for 5 seconds, scanning will resume automatically.

If you don't wish to listen to a busy channel, briefly rotate the **Channel** Control while the radio is paused on that channel. The busy channel will be temporarily removed from the scan group to allow time for the channel to become clear again and scanning will continue. The skipped channel will be reinstated in the scan sequence after 30 seconds (see Auto Skip on previous page).

If you press the **PTT** while the radio is scanning, the scan will pause and the radio will transmit on the working channel. After the channel has remained been clear for 5 seconds scanning will resume.

If your radio pauses on a busy channel and you wish to talk on that channel, simply press the **PTT** during a break in the conversation. If the busy channel was not your working channel, it now becomes your new working channel, replacing your previous working channel. Once your communication has finished and the channel has been clear for 5 seconds, scanning will resume.

If you need to use your Priority channel (for an urgent call), briefly press the **PRI** key. The scan will be cancelled and the radio will jump straight to the Priority channel.

GROUP SCAN

Group Scan allows you to scan a number of channels for activity while also monitoring your Priority channel. The receiver will scan the other channels **ONLY WHILE THERE ARE NO SIGNALS ON THE PRIORITY CHANNEL**. If a signal appears on the priority channel it will override any signals being received on any of the other channels. In addition, if you press the **PTT** at any time, the radio will transmit on the priority channel.





Example: Scanning channels 1 – 8 with priority channel 20 in Group Scan

Selecting Group Scan

1. Press and hold the **Channel** Control to enter the Menu. 'br' will be displayed.
2. Press the **Channel** Control repeatedly until 'Sc' (Scan) is displayed.
3. Rotate the **Channel** Control to select 'GS' (Group Scan).

When finished, press and hold the **Channel** Control to return to normal operation.

Programming the Scan Memory

1. Select the required channel using the **Channel** Control.
2. Check to see if the Scan symbol  is displayed on that channel.
 - If  is displayed, the selected channel is already in the Scan memory. Press and hold the **SCAN** key to remove it.  will disappear.
 - If  is not displayed, the selected channel is not in the Scan memory. Press and hold the **SCAN** key to add the selected channel to the Scan memory.  will now be displayed on that channel.

Repeat to add or remove other channels in the scan memory.

Select your Priority Channel

Program your Priority channel as described earlier under 'Priority Channel'.

To begin Scanning

Press the **SCAN** key. A high beep will be heard and the  icon will animate. During this time the channel numbers will change rapidly as the channels are scanned with the Priority channel will be scanned every fourth channel.

If a signal appears on the Priority channel – at any time – the radio will switch directly to the Priority channel and will stay there for as long as the channel remains busy. During this

time you can transmit and receive on the Priority channel. Once the Priority channel has been clear for 5 seconds the radio will resume scanning the other channels.

If a signal appears on any other channel, scanning will pause on that channel and will remain there while the channel is busy – as long as there are no signals on the Priority channel. During this time, the receiver will continue to check the Priority channel every 2 seconds resulting in a series of small breaks in the reception of the busy channel. Once the signal has gone and there has been no activity for 5 seconds, the radio will resume scanning.

To transmit on the Priority channel at any time, simply press the **PTT**. The radio will switch straight to the Priority channel. When you have finished your conversation and there has been no further activity for 5 seconds, the radio will resume scanning the other channels.

If you don't wish to listen to a busy channel, briefly rotate the **Channel** Control while the radio is paused on that channel. The busy channel will be temporarily removed from the scan group to allow time for the channel to become clear again and scanning will continue. The skipped channel will be reinstated in the scan sequence after 30 seconds (see Auto Skip on page 10).

If the radio is paused on a busy channel and you want to remain there, briefly press the **SCAN** key. The radio will exit Scan and remain on the busy channel. At this point you will no longer be monitoring the Priority channel.

To resume Group scanning press the **SCAN** key again.

If you need to use your Priority channel (for an urgent call), briefly press the **PRI** key. The scan will be cancelled and the radio will jump straight to the Priority channel.

NETWORK SCAN (NET-SCAN)

Net-Scan allows a group of radio users to maintain communications even when the band is congested. To achieve this all members of the Net-Scan group must share a common CTCSS/DCS code and a common set of scan channels.

Once activated, Net-Scan's intelligent scanning software keeps track of clear channels within your scan group. When

any member of the group transmits, their radio automatically selects a clear channel to transmit on. Other radios scanning in the same Net-scan group will lock onto that channel allowing all members of the group to join the conversation. If a signal from outside your Net-Scan group appears on the chosen channel (either with no code or the wrong code), the group will automatically switch to a new clear channel at the next transmission. In this way the group can continue to communicate with minimal interference to or from other users.

Enabling Net-Scan

Net-Scan is normally switched off by default but can be enabled through your radio's Menu.

NOTE: When you enable Net-Scan you will also be prompted to choose a suitable CTCSS or DCS tone to be used by your Net-Scan group. All members of your Net-Scan group must use this same code.

To enable Net-Scan

1. Press and hold the **Channel** Control to enter the Menu. 'br' will be displayed.
2. Press the **Channel** Control repeatedly until 'nS' (Network Scan) is displayed.
3. Rotate the **Channel** Control clockwise one click to view the current setting.
4. Rotate the **Channel** Control further clockwise to choose CTCSS tones 01 – 50. When CTCSS tones are selected **S** flashes.
5. Continue to rotate the **Channel** Control clockwise past CTCSS tone 50 to select DCS tones 01 – 104 (A4). When DCS tones are selected, **S** flashes.



Netscan off



Netscan with CTCSS tone 50



Netscan with DCS tone 104 (A4).

Since there are 104 DCS tones and only two characters available to display them, DCS tones 100 to 104 are labelled A0 to A4 on the display.

6. To disable Net-Scan, rotate the **Channel** Control fully counter-clockwise to select OFF. 'oF' is displayed.

When finished, press and hold the **Channel** Control to return to normal operation.

Selecting Net-Scan

When Net-Scan is enabled, a Network Scan option becomes available in the scan group selection. To select the Network Scan option;

1. Press and hold the **Channel** Control to enter the Menu. 'br' will be displayed.
2. Press the **Channel** Control repeatedly until 'Sc' (Scan) is displayed.
3. Rotate the **Channel** Control to select 'nS' (Network Scan).



When finished, press and hold the **Channel** Control to return to normal operation. The radio is now in the Network Scan mode.



Programming channels into Net-Scan.

All radios in your Net-Scan group must have the same channels programmed into their Net-Scan memory. Your radio's Net-Scan memory has already been factory programmed with 43 of the available 80 channels. The remaining 37 channels, which consist of the 32 repeater input/output channels, 2 telemetry channels and 3 guard-band channels, have not been included to minimise the risk of interference to other services on these channels.

To add or remove Net-Scan channels

With Net-Scan mode enabled, select the require channel using the **Channel** Control.

• If the channel is currently in the Net-Scan group the  icon will be visible above the channel display. To remove the channel, hold the **SCAN** key until a low beep is heard.  will disappear indicating the channel is no longer in memory.

• If the  icon is not visible above the channel display, the selected channel is not in the Net-Scan memory. To add it, hold the **SCAN** key until a high beep is heard.  will appear to confirm the channel is now in memory.

Repeat to add or remove further Net-Scan channels.

IMPORTANT: When adding channels to Net-Scan, please consider the following:

- The transmitter on your radio is inhibited on channels 22, 23 and channels 61, 62, 63 as required by the ACMA. This makes these channels unsuitable for use as Net-Scan channels.
- You should not include any repeater channels unless you have confirmed that the channel is not allocated to a repeater in your area. If you add an active repeater channel into your Net-Scan, you or others in your Net-Scan group may cause interference to other repeater users on that channel.

Starting Net-Scan

With Net-Scan mode enabled, press **SCAN**. A high beep will be heard and the  icon will animate. During this time the channel numbers will change rapidly as the channels are scanned

Using Net-Scan

When a member of the group initiates a transmission their radio will automatically select a clear channel to transmit on. Other radios scanning in the same Net-Scan group will locate the transmission by identifying the groups CTCSS/DCS code and open their Squelch allowing the transmission to be heard across the entire group. When the transmission ends, all radios in the group will immediately resume scanning.

If a member of the group responds to the initial transmission, they will automatically re-use the same channel as long as the channel remains free of other signals. This allows

the radios in the group to respond more quickly to further transmissions from others in the group.

If at any time, a signal from outside your Net-Scan group appears on the channel (either with no code or the wrong code), the channel will be discarded and a new clear channel will be selected at the next transmission. The other radios in the group will then locate the new channel allowing the conversation to continue seamlessly without any input from the user.

Ending the scan

To stop scanning, briefly press the **SCAN** key. A low beep will be heard and the animated  icon will stop. As long as the radio was not on a busy channel, it will return to the last channel you selected, otherwise it will stay on the busy channel.

CTCSS & DCS

The standard Squelch system is fine for quieting the radio in most applications. However, it operates solely on signal strength which means that it will always open to any signal that is strong enough. If the channel is busy with other stations the Squelch will be constantly opening making it difficult to determine which calls are meant for you.

CTCSS (Continuous Tone Coded Squelch System) and DCS (Digital Coded Squelch) are similar Squelch quieting systems that provide selective audio muting using sub-audible signalling. When enabled, only signals with a matching sub-tone will be heard in the speaker. This effectively creates a channel that is silent to all traffic except those you wish to hear.

Choosing CTCSS or DCS

The CTCSS system uses 1 of 50 low frequency tones to open and close the Squelch on the radio. The DCS system is similar to CTCSS but uses 1 of 104 digital codes to control the Squelch. There is no difference in performance or function between the different tone sets so choosing which tone system to use will largely depend on the other radios you talk with. If others already use CTCSS or DCS, you should select the tone system that matches theirs. If the users you talk to don't currently use CTCSS or DCS then you can make your

own choice. Both types are included in the radio to maintain compatibility with other radio systems.

CTCSS Tone set compatibility

The GME CTCSS tone set comprises a table of 50 tones made up of the standard CCIR-38 Tone Set plus an additional 12 tones added to the end. If communicating with other brands of radios that only use the CCIR-38 tone set, please select from one of the first 38 tones to ensure compatibility with these radios.

If communicating with other GME radios, you may choose from any of the 50 tones. However, please refer to the tone set tables listed in each radio's Instruction manual for compatibility because, although the same 50 tones are available in all GME radios, the tones used in older GME models may be listed in a different order to those in your radio.

To enable a CTCSS or DCS code

1. Press and hold the **Channel** Control to enter the Menu. 'br' will be displayed.
2. Press the **Channel** Control repeatedly until 'ct' (CTCSS) is displayed.
3. Rotate the **Channel** Control one click. If CTCSS/DCS is currently switched off, 'oF' is displayed.
4. Rotate the **Channel** Control to the right to select a CTCSS tone. CTCSS tones are labelled 01 – 50 and are accompanied by a flashing **S** icon.
5. Continue rotating the **Channel** Control to the right, past CTCSS tone 50, to select a DCS code. DCS codes are labelled 01 – A4 (104) and are accompanied by a flashing **S** icon.
6. To switch CTCSS/DCS off, rotate the **Channel** Control to the left until 'oF' is displayed.

When finished, press and hold the **Channel** Control to return to normal operation.

NOTE: The tone you select will be used for all channels that have 'Silent' enabled.

← Rotate Left		Rotate Right →
oF	CTCSS Tones 1-50 (S)	DCS Tones 1-A4 (104) (S)

Since there are 104 DCS tones and only two characters available to display them, DCS tones 100 to 104 are labelled A0 to A4 on the display.

Enabling CTCSS/DCS on a channel (Silent mode)

When 'Silent' mode is enabled on a channel, the CTCSS/DCS system will prevent the Squelch on your radio from opening unless the incoming signal matches your selected CTCSS/DCS tone. If other users are using the same channel but are not using your selected CTCSS/DCS tone, the busy icon **ME** will appear on the display indicating the signal is being received, however no sound will be heard in the speaker. Only when someone transmits on the channel using your selected CTCSS/DCS tone will the Squelch open to allow you to hear the signal.

Silent mode can be enabled on any channel you choose (except emergency channel 5/35).

To enable Silent mode on a channel

1. Select the required channel.
2. Press and hold the **SQL** key until a high beep is heard.
3. An **S** icon (CTCSS) or **S** icon (DCS) will be displayed in the lower right of the display to indicate Silent mode is now enabled on that channel.

NOTE: If the CTCSS/DCS tone in your radio has been set to 'oF' you will not be able to enable Silent mode.



To disable Silent mode on a channel

1. Select the required channel. An **S** icon (CTCSS) or **S** icon (DCS) will be displayed indicating Silent mode is currently enabled on that channel.
2. Press and hold the **SQL** key until a low beep is heard.
3. The **S** or **S** icon will disappear indicating Silent mode is now disabled on that channel.

IMPORTANT: When Silent mode is enabled on a channel, you should always check the busy icon  for signs of traffic on the channel before you transmit to ensure you do not accidentally transmit over the top of another user.

Busy Lockout

To help prevent accidental transmissions over the top of other users, the TX3500S incorporates a Busy Lockout feature.

The Busy Lockout function detects when others outside your CTCSS/DCS group are transmitting on the channel and prevents your radio from transmitting over them. If the channel is busy and you press the **PTT** the radio will emit a warning beep and the  icon won't be displayed. When you release the **PTT**, look for the  icon on the display as an indicator that the channel is in use. If the channel is busy, simply wait until the channel is clear and press the **PTT** again.

NOTE: You can also press the Monitor key to open the Squelch and listen for signals on the channel before transmitting (see Monitor Function directly below).

To enable Busy Lockout

1. Press and hold the **Channel** Control to enter the Menu. 'br' will be displayed.
2. Press the **Channel** Control repeatedly until 'bL' (Busy Lockout) is displayed.
3. Rotate the **Channel** Control one click. The current setting is displayed.
4. Rotate the **Channel** Control to the right to enable busy lockout. 'on' will be displayed.
5. Rotate the **Channel** Control to the left to disable busy lockout. 'oF' will be displayed.

When finished, press and hold the **Channel** Control to return to normal operation.

Monitor Function

If the busy icon  shows that the channel is busy, but you cannot hear any sound, the signal is probably using a different CTCSS/DCS tone to yours.

If you wish to listen to the signal to confirm that someone else is using the channel, press and hold the **Volume** control. This activates the 'monitor' function which temporarily disables the CTCSS/DCS system in your radio to allow the signal to be heard in the speaker. When the **Volume** control is released the channel will become quiet again.

NOTE: While the **Volume** control is pressed, the  icon flashes.

RECEIVING (RX) ONLY CHANNELS

The radio includes support for up to 19 RX-only dealer programmable frequencies in the range of 403-520MHz.

RX-only channels, when installed, can be found above channel 80.



CONFIGURATION MENU

The TX3500S menu provides a convenient method of customising some of the radio's functions. The following parameters are available.

To access the menu

1. Press and hold the **Channel** Control. 'br' will be displayed.
2. Press the **Channel** Control repeatedly until the required setting ID is displayed.
3. Rotate the **Channel** Control to select the required option.

When finished, press and hold the **Channel** Control to return to normal operation.

ID	DESCRIPTION	OPTIONS
br	Brightness	Rotate for LCD backlight brightness
cl	Colour	Rotate for LCD backlight colour
li	Lightness	Rotate for LCD backlight lightness
bp	Key Beep Volume	Rotate to adjust key beep volume
ct	CTCSS/DCS	oF – CTCSS OFF 01 – 50 with S icon flashing – CTCSS Tones 01 – A4 with S icon flashing – DCS Codes
nS	Netscan	oF – Netscan OFF CTCSS Tones 01 – 50 with S icon flashing DCS Codes 01 – 104 (A4) with S icon flashing
St	Silent Squelch Tail	oF – Off (tail is audible) on – On (tail is silent)
dL	Dynamic Volume	oF – Off on – On
Sc	Scan Group	oS – Open Scan selected GS – Group Scan selected nS – Netscan selected (only when Netscan is enabled)
bl	Busy Lockout	oF – Off on – On
FL	Filter	 Narrow band Filter selected  Wide Band Filter selected

INSTALLATION

The TX3500S is supplied with a slim, slide on mounting cradle. The cradle can be screwed or bolted to any convenient location in your vehicle (under or above the dash, on the centre console, etc.) using the mounting slots provided in the cradle.

The TX3500S contains a built-in speaker and should be installed in a convenient location in the vehicle's cabin using the mounting slots provided in the base. For maximum sound from the internal speaker, we recommend the cradle be mounted above the radio to minimise any obstruction of the speaker.

Alternatively the TX3500S can be installed in a less audible location and an extension speaker used instead. When installing the radio, avoid mounting it close to heaters or air conditioners.

Console mounting

A flush mounting DIN adapter MBD001 is available as an optional accessory. The adapter includes mounting brackets and a specially designed front panel escutcheon to suit most vehicle installations. See your nearest GME retailer for details.

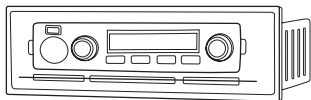

Din Adapter MBD001

When installing the cradle

Avoid mounting close to heaters or air conditioners. Screw the mounting cradle to a firm surface and slide the TX3500S into the cradle from the front until it clicks into place. Finally, connect the power lead and antenna cable to the sockets on the radio's rear panel.

Mounting the cradle

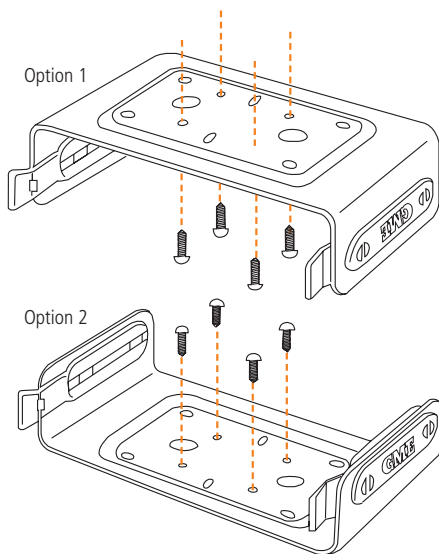

Fitting the radio

Slide radio fully into cradle until it 'clicks' into place.

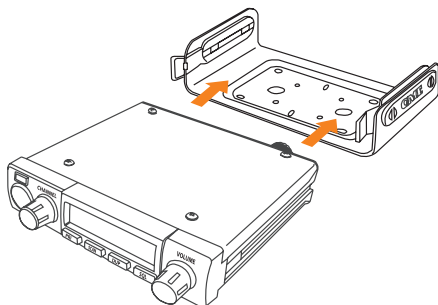

Removing the radio

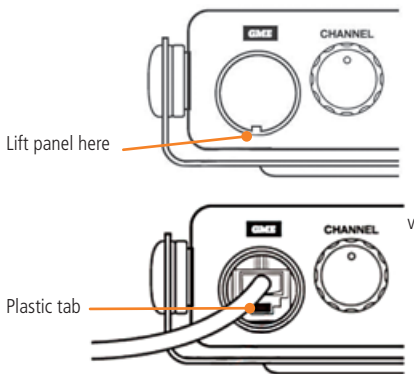
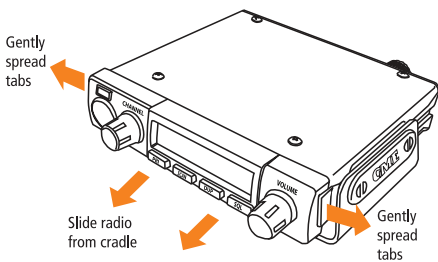

Fitting the microphone

The microphone uses a miniature 6 pin telephone style plug which fits the TX3500S' microphone socket. The TX3500S has two microphone sockets – one on the front panel and one on the rear panel. The microphone can be plugged into either socket. If connecting the microphone to the rear socket, an optional extension cable LEM6P is available to bring the microphone connection to a more accessible location.

To fit the microphone: Front

1. The front microphone cover is a press fit. To remove, simply insert the end of a paper clip or similar into the small slot in the edge of the cover and lift the cover away from the panel.
2. Place the microphone plug so the plastic tab faces downwards, then press plug into the socket until it 'clicks'.
3. Gently press the rubber strain relief into the hole surrounding the socket so that the slot around the strain relief fits neatly inside the lip of the hole.

Rear

1. The rear microphone cover hinges from the top. Simply lift the cover from the bottom. The cover will remain connected to the chassis.
2. Place the microphone plug so the plastic tab faces downwards, and press the plug into the socket until it 'clicks'.

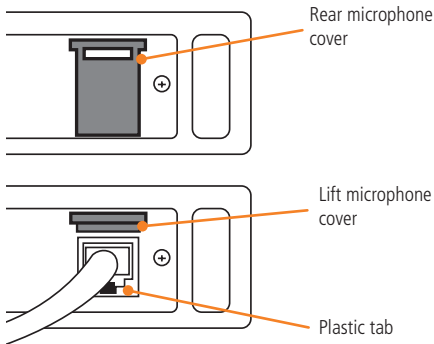

Removing the microphone

1. For front panel connections, squeeze the rubber strain relief near the front panel to disengage the slot, and slide the strain relief back along the microphone cord.
2. Squeeze the plastic tab on the microphone plug towards the plug to unlock it while gently pulling the plug outwards. If the plug does not come out easily, the tab has not released correctly and should be squeezed again.

DC POWER CONNECTION

The TX3500S is designed for 13.8 volt DC, negative earth installations only (i.e. where the negative terminal of the battery is connected to the chassis or frame of the vehicle).

There are two recommended methods of installation.

Radio remains ON when the ignition switch is OFF

Connect the radio's negative (black) lead to the vehicle's chassis, or if preferred, directly to the battery's negative terminal. The radio's positive (red) lead should be connected via the 2 amp fuse to the battery's positive terminal.

Alternatively, the positive lead could be connected into the fuse box at a point that has +13.8 volts continuously available (on the battery side of the ignition switch) via the 2 amp fuse.

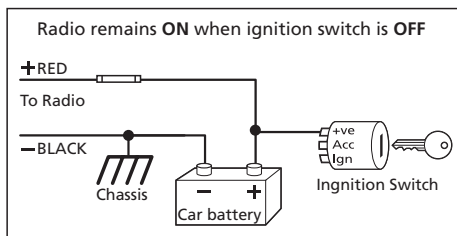

Radio turns ON and OFF with the ignition switch

Connect the radio's negative (black) lead to the vehicle's chassis, or if preferred, directly to the battery's negative terminal. The radio's positive (red) lead should connect to an accessory point in the vehicle's fuse box via the 2 amp fuse.

This point should supply +13.8 volts only when the ignition switch is turned ON or in the ACCESSORY position via the 2 amp fuse.

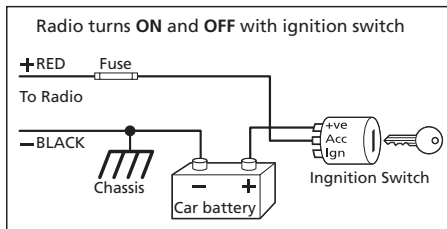

HIGH VOLTAGE WARNING

The TX3500S has a built-in, high voltage detection system to warn you if an over-voltage situation occurs. If the power supply voltage exceeds 18 volts DC, the channel display will flash 'hi dc' for 5 seconds when the unit is first turned on, or at the time the voltage exceeds 18 volts. In addition, when transmitting, the TX indicator will flash and the transmitter will select low output power.

If the over-voltage warning appears you should switch your TX3500S OFF and disconnect it from the power source, before locating the cause of the trouble.

Once the High Voltage warning has been triggered, and you have fixed the source of the problem, you will need to switch the TX3500S OFF then ON again to reset it.

The power source must not exceed 30 volts.

ANTENNA CONNECTION

It is essential to select a good quality, high efficiency, 477 MHz antenna. A poor quality antenna or one not designed for the specific frequency band you are using will give very poor performance.

GME have a wide range of suitable 477 MHz UHF CB antennas to suit most installations and applications. We recommend contacting your local GME retailer for advice. Connect the antenna cable to the rear antenna socket using a PL259 coaxial connector.

NOISE SUPPRESSION

The inherent design of FM transceivers results in a high level of resistance to ignition and electrical interference. However in some installations it may be necessary to take additional steps to help reduce or eliminate noise interference. During installation, try to route the DC battery leads, the antenna lead or any accessory wires away from the engine compartment, ignition or alternator wiring. If the noise continues, it may be necessary to fit a suppression kit in which case we recommend you consult an auto electrician for advice specific to your installation.

Higher frequency electrical interference caused by electric motors can be suppressed directly at the motor terminals.

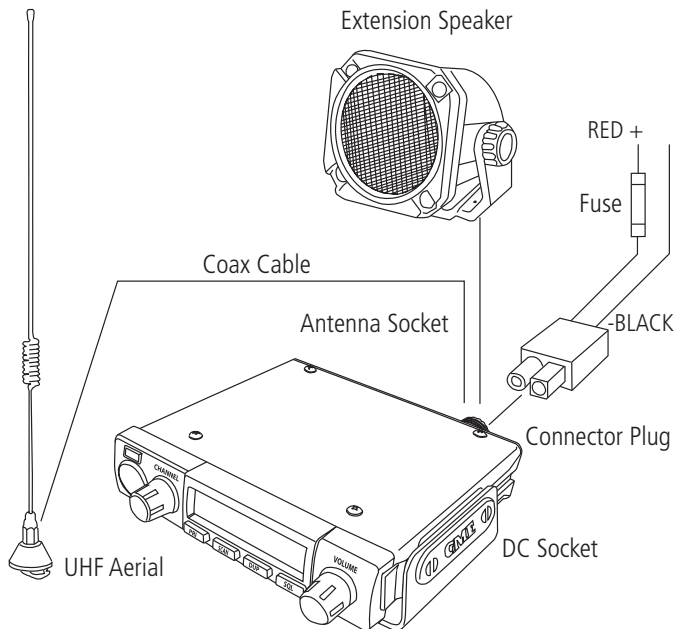

CTCSS TONE FREQUENCIES CHART

No.	Frequency	No.	Frequency	No.	Frequency	No.	Frequency
1	67.0	14	107.2	27	167.9	40	159.8
2	71.9	15	110.9	28	173.8	41	165.5
3	74.4	16	114.8	29	179.9	42	171.3
4	77.0	17	118.8	30	186.2	43	177.3
5	79.7	18	123.0	31	192.8	44	183.5
6	82.5	19	127.3	32	203.5	45	189.9
7	85.4	20	131.8	33	210.7	46	196.6
8	88.5	21	136.5	34	218.1	47	199.5
9	91.5	22	141.3	35	225.7	48	206.5
10	94.8	23	146.2	36	233.6	49	229.1
11	97.4	24	151.4	37	241.8	50	254.1
12	100.0	25	156.7	38	250.3	–	–
13	103.5	26	162.2	39	69.4	–	–

DSC TONE CHART

DCS	CODE	DCS	CODE	DCS	CODE	DCS	CODE	DCS	CODE	DCS	CODE
1	023	19	116	37	225	55	325	73	452	91	627
2	025	20	122	38	226	56	331	74	454	92	631
3	026	21	125	39	243	57	332	75	455	93	632
4	031	22	131	40	244	58	343	76	462	94	654
5	032	23	132	41	245	59	346	77	464	95	662
6	036	24	134	42	246	60	351	78	465	96	664
7	043	25	143	43	251	61	356	79	466	97	703
8	047	26	145	44	252	62	364	80	503	98	712
9	051	27	152	45	255	63	365	81	506	99	723
10	053	28	155	46	261	64	371	82	516	100	731
11	054	29	156	47	263	65	411	83	523	101	732
12	065	30	162	48	265	66	412	84	526	102	734
13	071	31	165	49	266	67	413	85	532	103	743
14	072	32	172	50	271	68	423	86	546	104	754
15	073	33	174	51	274	69	431	87	565	-	-
16	074	34	205	52	306	70	432	88	606		
17	114	35	212	53	311	71	445	89	612	-	-
18	115	36	223	54	315	72	446	90	624	-	-

UHF CB OPERATING FREQUENCIES

CH	Frequency (MHz)	CH	Frequency (MHz)	CH	Frequency (MHz)	CH	Frequency (MHz)
1	476.425	21	476.925	41	476.4375	61	476.9375
2	476.450	22	476.950	42	476.4625	62	476.9625
3	476.475	23	476.975	43	476.4875	63	476.9875
4	476.500	24	477.000	44	476.5125	64	477.0125
5	476.525	25	477.025	45	476.5375	65	477.0375
6	476.550	26	477.050	46	476.5625	66	477.0625
7	476.575	27	477.075	47	476.5875	67	477.0875
8	476.600	28	477.100	48	476.6125	68	477.1125
9	476.625	29	477.125	49	476.6375	69	477.1375
10	476.650	30	477.150	50	476.6625	70	477.1625
11	476.675	31	477.175	51	476.6875	71	477.1875
12	476.700	32	477.200	52	476.7125	72	477.2125
13	476.725	33	477.225	53	476.7375	73	477.2375
14	476.750	34	477.250	54	476.7625	74	477.2625
15	476.775	35	477.275	55	476.7875	75	477.2875
16	476.800	36	477.300	56	476.8125	76	477.3125
17	476.825	37	477.325	57	476.8375	77	477.3375
18	476.850	38	477.350	58	476.8625	78	477.3625
19	476.875	39	477.375	59	476.8875	79	477.3875
20	476.900	40	477.400	60	476.9125	80	477.4125

	Emergency use only		Repeater output channels (Duplex)
	Telemetry / SelCall use only. Voice transmission is inhibited as required by AS/NZS 4365.2011		11 Officially designated call channel
	Guard band channel. Transmission is inhibited as required by AS/NZ 4365.2011		40 Road channel
	Repeater input channels (Duplex)		18 Caravan and motor-home
			10 4WD / Off-road

SPECIFICATIONS

ELECTRICAL

General

Compliant Specification:	Meets AS/NZS 4365 for radio communications equipment in the UHF citizen and personal radio service.
Frequency Range TX:	476.425-477.4125 MHz
Number of Channels:	80
Channel Spacing:	12.5 kHz
Operation Mode:	Simplex or half Duplex with repeater talk around.
Scanning Speed:	25 ms per channel (40 channels per second).
Antenna Impedance:	50 Ohms nominal
Nominal Battery Voltage:	12 volts DC
Operating Voltage Range:	10-16 volts DC
Battery Polarity:	Negative Earth
Standard Test Voltage:	13.8 volts DC
Overvoltage Protection:	30 volts DC maximum. At 18 volts DC the channel display flashes 'Hi DC' for 5 seconds on receive. The RF power is reduced and TX flashes on transmit.
Reverse Voltage Protection:	Diode Crowbar
Overcurrent Protection:	In-line 2 Amp Fuse
Operating Temperature:	-10°C to 60°C

Transmitter

RF Output:	5 watts
Spurious Emission:	< - 70 dBc
Frequency Error:	< \pm 1.5 kHz
Modulation:	FM
Maximum Deviation:	< \pm 2.5 kHz at + 20 dB AF limiting.
Transmit Frequency Response:	+ 6 dB per octave 300 Hz to 3 kHz + 1-3 dB.
Demodulated Audio Signal to Noise:	> 45 dB unweighted
Current Consumption:	1.7 Amps with 50 Ohm termination.

Receiver

Intermediate Frequencies:	38.85 MHz, 450 kHz
Sensitivity:	-122 dBm for 12 dB SINAD unweighted
Selectivity:	-6 dB at + 3.5 kHz -60 dB at \pm 12.5 kHz
Intermodulation Immunity:	-72 dB
Blocking Immunity:	-98 dB
Spurious Response Immunity:	70 dB
Audio Output Power:	3 watts average into 4 Ohms
Audio Signal to Noise:	> 45 dB unweighted
Receive Frequency Response:	-6 dB/Octave de-emphasis 300 Hz to 3 kHz + 1-3 dB
Current Consumption:	< 175 mA muted 750 mA full volume
Conducted Spurious Emission:	< -70 dBm

MECHANICAL SPECIFICATIONS & CONNECTIONS

Dimensions:	29 (H) x 128 (L) x 117 (D) mm
Weight:	450 grams
12 Volt Power Supply:	Two core cable with bulkhead connector in rear panel
Antenna:	SO239 panel socket
External Speaker:	3.5 mm mono jack
Microphone Port:	6 way telephone style with rubber strain relief

Specifications are subject to change without notice or obligation

STANDARD COMMUNICATIONS CONTRACT WARRANTY AGAINST DEFECTS

This warranty against defects is given by Standard Communications Pty Ltd ACN 000 346 814 (We, us, our or GME). Our contact details are set out in clause 2.7.

1. Consumer guarantees

- 1.1 Our goods come with guarantees that cannot be excluded under the Australian Consumer Law. You are entitled to a replacement or refund for a major failure and for compensation for any other reasonably foreseeable loss or damage. You are also entitled to have the goods repaired or replaced if the goods fail to be of acceptable quality and the failure does not amount to a major failure.
- 1.2 To the extent we are able, we exclude all other conditions, warranties and obligations which would otherwise be implied.

2. Warranty against defects

- 2.1 This warranty is in addition to and does not limit, exclude or restrict your rights under the Competition and Consumer Act 2010 (Australia) or any other mandatory protection laws that may apply.
- 2.2 We warrant our goods to be free from defects in materials and workmanship for the warranty period (see warranty table) from the date of original sale (or another period we agree to in writing). Subject to our obligations under clause 1.2, we will at our option, either repair or replace goods which we are satisfied are defective. We warrant any replacement parts for the remainder of the period of warranty for the goods into which they are incorporated.
- 2.3 To the extent permitted by law, our sole liability for breach of a condition, warranty or other obligation implied by law is limited
- (a) in the case of goods we supply, to any one of the following as we decide –
 - (i) the replacement of the goods or the supply of equivalent goods;
 - (ii) the repair of the goods;
 - (iii) the cost of repairing the goods or of acquiring equivalent goods;
 - (b) in the case of services we supply, to any one of the following as we decide –
 - (i) the supplying of the services again;
 - (ii) the cost of having the services supplied again.
- 2.4 For repairs outside the warranty period, we warrant our repairs to be free from defects in materials and workmanship for three months from the date of the original repair. We agree to re-repair or replace (at our option) any materials or workmanship which we are satisfied are defective.

- 2.5 We warrant that we will perform services with reasonable care and skill and agree to investigate any complaint regarding our services made in good faith. If we are satisfied that the complaint is justified, and as our sole liability to you under this warranty (to the extent permitted at law), we agree to supply those services again at no extra charge to you.
- 2.6 To make a warranty claim you must before the end of the applicable warranty period (see warranty table), at your own cost, return the goods you allege are defective, provide written details of the defect, and give us an original or copy of the sales invoice or some other evidence showing details of the transaction.
- 2.7 Send your claim to: Standard Communications Pty Ltd.
PO Box 96 Winston Hills, NSW 2153, Australia.
Tel: (02) 8867 6000 Fax: (02) 8867 6199
Email: servadmin@gme.net.au
- 2.8 If we determine that your goods are defective, we will pay for the cost of returning the repaired or replaced goods to you, and reimburse you for your reasonable expenses of sending your warranty claim to us.

3. What this warranty does not cover

- 3.1 This warranty will not apply in relation to:
- (a) goods modified or altered in any way;
 - (b) defects and damage caused by use with non Standard Communications products;
 - (c) repairs performed other than by our authorised representative;
 - (d) defects or damage resulting from misuse, accident, impact or neglect;
 - (e) goods improperly installed or used in a manner contrary to the relevant instruction manual; or
 - (f) goods where the serial number has been removed or made illegal.
4. Warranty period
- 4.1 We provide the following warranty on GME and Kingray products. No repair or replacement during the warranty period will renew or extend the warranty period past the period from original date of purchase.

PRODUCT TYPE	WARRANTY PERIOD
All fixed mount 'S' model UHF CB radios	5 years

For more information call or visit us:

 **1300 463 463**  **gme.net.au**

A division of Standard Communications Pty Ltd.

Head Office: PO Box 96, Winston Hills, NSW 2153, Australia.

New Zealand: PO Box 58446 Botany, Auckland, 2163, NZ. T: (09) 274 0955.

All international enquiries email: export@gme.net.au

Part Number: 310970 Drawing Number: 48421-2