



# G·COM

## GX400

27 MHz RADIO



INSTRUCTION MANUAL

# CONTENTS

WARNING/SAFETY INFORMATION.....	3
INTRODUCTION .....	3
INSTALLATION GUIDELINES.....	3
SUPPLIED WITH.....	3
FEATURES.....	4
SWITCHING BANDS .....	4
CONTROLS.....	4
GENERAL OPERATION.....	6
Volume on/off .....	6
Squelch control .....	6
Channel selection.....	6
Display brightness .....	6
Transmitting.....	6
Noise Limiter.....	6
Scanning.....	7
Priority channels (PR1/PR2).....	8
Key Lock function.....	8
OPERATION ON THE AUSTRALIAN MARINE BAND .....	8
Dual Watch (marine mode).....	8
Triple Watch (marine mode).....	9
Triple Watch features .....	9
Marine Band procedures.....	10
Emergency procedures.....	10
OPERATION ON THE CB BAND .....	11
Dual Watch (CB mode).....	11
Triple Watch (CB mode).....	12
Triple Watch features .....	12
INSTALLATION .....	14
General.....	14
Installing the unit .....	14
DC connections .....	15
Antenna installation .....	16
Extension speaker .....	16
Noise suppression .....	16
Disconnecting the microphone.....	17
SPECIFICATIONS .....	18
STANDARD COMMUNICATIONS WARRANTY AGAINST DEFECTS .....	19

## WARNING/SAFETY INFORMATION

The GX400 is a radio transmitting device.

- Do not transmit near electrical blasting equipment or in explosive atmospheres.
- Do not allow children to operate a radio transmitter unsupervised.
- The antenna used for this radio must be properly installed and maintained and must provide a separation distance of at least 34 cm (13.4 inches) from all persons and must not be collocated or operated in conjunction with any other antenna or transmitter. Never transmit if any person is closer than the specified distance to the antenna.
- Changes or modifications to this product or use of accessories not expressly approved by GME, or operation of this product in any way other than as provided in the GME Owner's Manual could void your authority to operate this product.

## INTRODUCTION

Congratulations. You have just purchased one of the most technically advanced 27 MHz radios in the world.

The GME GX400 is a 27 MHz AM radio that combines both Marine and Citizens Band functions into the one radio. The GX400 has a number of enhanced features including fully user programmable channel scanning, safety channel selection (Channel 88 in marine mode, Channel 8 in CB mode), speaker microphone, two Priority channels and a backlit Liquid Crystal Display (LCD) with dimming function.

With its compact size and IPX7 design it can easily be installed into almost any mounting location in your boat, motor vehicle, motor cycle etc.

Please read this manual thoroughly to ensure you get the best from the GX400's features.

For users in New Zealand, United States of America, Canada, South Africa or Papua New Guinea, please refer to amendment for local frequencies, channel allocations and licensing requirements.

## INSTALLATION GUIDELINES

- Do not install the radio near an airbag or in an area where an airbag may deploy. If an airbag is obstructed by the radio, it may not deploy as expected. It could also propel the radio with enough force to cause serious injury.
- Avoid touching the heat sink at the rear of the radio while the radio is in use. The heat sink can become hot during prolonged use.
- Do not install the radio in front of a vehicle heater. The radio requires a cool airflow over the rear heat sink when transmitting to maintain efficiency.
- Do not make unapproved modifications to the radio. Such modifications could void the warranty and cause the radio to operate outside its approved specifications.

## SUPPLIED WITH

Cabin cover	Microphone bracket
Mounting bracket and gimbals knobs	DC power lead
Mounting hardware	Instruction manual

## FEATURES

- Ingress protection to IPX7\*
- LCD with lamp dimming function
- Rotary squelch control
- Channel scanning with memory
- Two user programmable Priority channels
- Dual Watch and Triple Watch functions
- Advanced noise limiter (NL) circuitry
- Surface mount technology
- User selection of Australian 27 MHz marine or 27 MHz CB channels
- Safety channel 88 for marine application (channel 8 for CB application)

\*Refer: <http://www2.gme.net.au/IPRatings>

## SWITCHING BANDS

The GX400 is capable of operating on both the Australian 27 MHz Marine Band and the Australian 27 MHz Citizens Band. This makes your radio very versatile in that it can be used in your vehicle, on a boat or even on a motorcycle or tractor.

When you first install your GX400, it should default to the 27 MHz Marine Band. When operating on the Marine Band the radio will display channels 68 – 98 and the  key will default to safety Channel 88.

To select the CB band, turn the radio OFF, then press and hold the **DW** key while turning the radio on again. The radio will now display channels 1 – 40 and the  key will default to road Channel 8. Repeat the sequence above to return to the Marine Band.

**NOTE:** Class licence 2001 prohibits the use of a Maritime Ship Station for land-based communications. When the Marine Band is selected, the GX400 should only be used for Ship-to-Ship, Ship-to-Shore or Shore-to-Ship communications.

## CONTROLS

### Front Panel

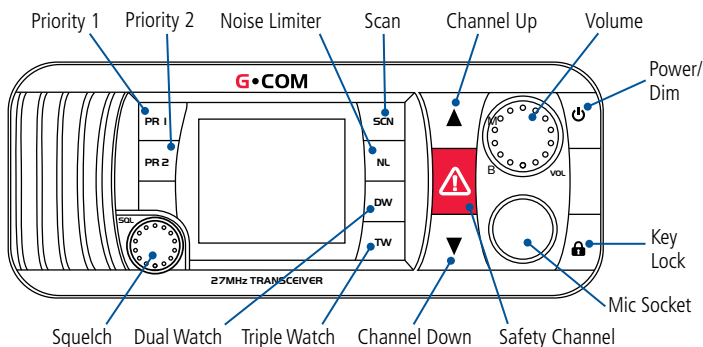

## Rear Panel

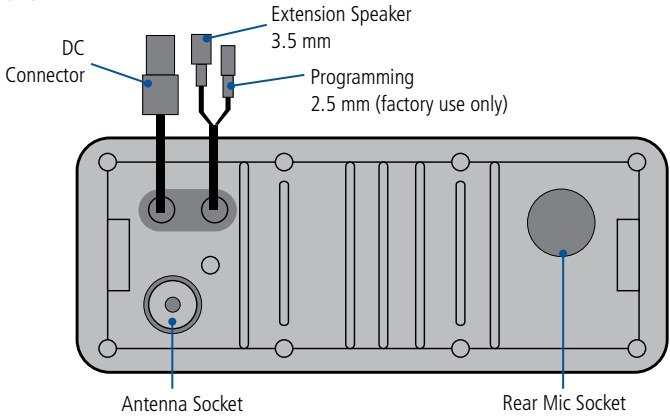

## LCD

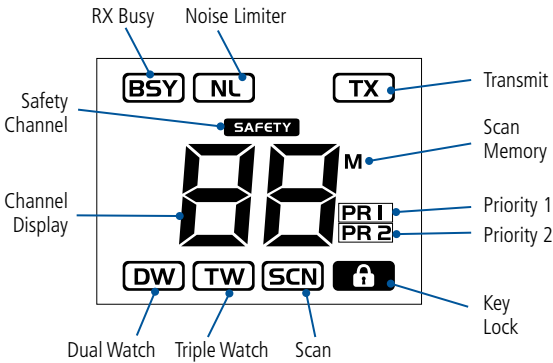

## MC616 Microphone

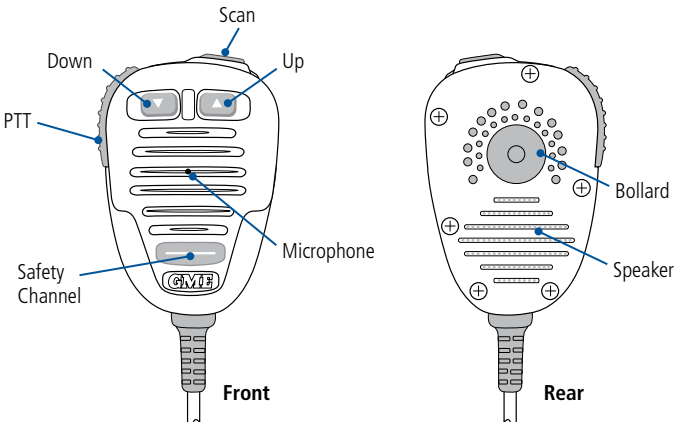

### VOLUME ON/OFF

---

To turn the GX400 on, briefly press the  key.

To adjust the volume, rotate the volume control. Rotate the volume control clockwise to increase the volume or counter-clockwise to reduce the volume.

.....  
**NOTE:** At minimum volume setting there is still sufficient volume to be heard in a quiet cabin environment.  
.....

To turn the GX400 off, press and hold the  key again.

### SQUELCH CONTROL



---

The squelch control is used to eliminate the background noise when there are no signals present. To adjust the squelch, first rotate it fully counter-clockwise until the background noise is heard, then slowly rotate it clockwise until the noise disappears. If there are signals on the channel, you should wait until the channel is clear (or select a quiet channel) before adjusting the squelch.

Once adjusted, the receiver will remain quiet as long as there are no signals present, but an incoming signal will override the squelch and be heard in the speaker. As the control is advanced further clockwise the squelch action is progressively increased and stronger incoming signals are needed to override it. To receive very weak signals or to disable the squelch, simply turn the control fully counter-clockwise.

### CHANNEL SELECTION

---

Select the required channel by briefly pressing the  or  keys. The selected channel is displayed on the LCD. Press and hold either key to quickly advance upwards or downwards through the channels. Release the key when the required channel is displayed.

### DISPLAY BRIGHTNESS

---

The LCD has three brightness levels to provide suitable lighting for day or night use.

#### To adjust the brightness

Briefly press the  key to cycle through the display brightness settings. The display brightness will cycle through Off, Dim and Bright. If the radio is switched off the selected brightness level will be retained in memory and will be restored when the radio is switched on again.

### TRANSMITTING

---

To transmit, press the **PTT** on the microphone. Hold the microphone 2 – 6 cm from your mouth and slightly to one side so your voice does not project directly into the microphone. Speak at a normal voice level. Your GX400 has a build-in speech processor which automatically controls the level of your transmitted voice. It is not necessary to raise your voice or shout into the microphone. Release the **PTT** to receive.

### NOISE LIMITER

---

The **NL** key activates an extremely effective noise limiter circuit which helps to eliminate most electrical impulse interference caused by engine ignition systems etc. This allows clearer reception of weak signals even under noisy electrical conditions. When the noise limiter is selected, 'NL' is displayed on the LCD.

## SCANNING

The Scan function allows a group of channels to be scanned for activity. Channels to be scanned can be programmed into the scan memory by the user.

By default your GX400 is supplied with all channels in the scan memory. You can remove or add channels as desired.

### To determine if a channel is stored in the scan memory

Select the required channel using the ▲ or ▼ key then check to see if 'M' is displayed to the right of the channel number. If 'M' is displayed, the channel is in the scan memory otherwise the channel is not in the scan memory.



Channel in scan memory



Channel not in scan memory

### To add or remove a channel from the scan memory

Select the required channel, then press and hold the **SCN** key until a beep is heard. If the channel was not in the scan memory, it will be added and 'M' will appear. If the channel was currently in the scan memory, it will be removed and 'M' will disappear.

### To scan

Adjust the **Squelch** control so the radio is quiet then briefly press the **SCN** key. A high beep will be heard, 'SCAN' will appear in the display and the channel numbers will change rapidly as the radio begins scanning. If a signal is found, the radio will pause on that channel and will remain there as long as the channel remains busy. Once the channel has been clear for 5 seconds, scanning will resume.

---

**NOTE:** You must have at least two channels programmed into the scan memory otherwise the radio won't scan.

---

### To change the scan direction

Press the ▲ or ▼ key. The radio will scan in the direction of the selected key.

### To skip over a busy channel and resume scanning

Briefly press the ▲ or ▼ key. Scanning will resume.

### To transmit on a busy channel

Wait for a break in the conversation then press the **PTT** key. The radio will exit the scan mode and stay on the channel allowing you to communicate with others on that channel.

To resume scanning briefly press the **SCN** key again.

---

**NOTE:** If the **PTT** is pressed while the radio is scanning, it will be ignored and a low beep will be heard when the **PTT** is released.

---

## To exit the Scan mode manually

Briefly press the **SCN** key. 'SCAN' will disappear from the display.

---

**NOTE:** Excessive noise on a channel can cause the scanner to pause on that channel even if there is no signal there. If this only happens on one channel, you may need to consider removing that channel from the scan memory. If it happens on all channels, you should try increasing the squelch setting.

---

## PRIORITY CHANNELS (PR1/PR2)

---

There are two Priority channel memories labelled PR1 and PR2 that allow you to store channels for instant recall.



To store a Priority channel, select the required channel using the ▲ or ▼ keys, then press and hold the required priority key (**PR1** or **PR2**) to store the channel under the designated key.



To recall a Priority channel, briefly press either **PR1** or **PR2**. The radio will instantly jump to the designated channel and the channel number will be displayed along with the associated 'PR1' or 'PR2' icon.

## KEY LOCK FUNCTION

---

The Key Lock allows most of the keys to be locked to prevent accidental key presses from changing the channel or the radio's settings. While the keys are locked only the Volume, Squelch and ▲ button controls are available.

To lock the keys, press and hold the  key for 1 second. The  icon is displayed and a high beep is heard.

To unlock the keys, press and hold the  key again. The  icon disappears and a low beep is heard.

## OPERATION ON THE AUSTRALIAN MARINE BAND

### Channel 88

Channel 88 is the designated 27 MHz marine safety channel and in many areas is monitored by coastal-watch and rescue organisations for emergency and safety purposes.

When making radio calls, you should make initial contact on Channel 88 then switch to another channel to continue your conversation. This leaves Channel 88 free for other calls or emergencies.

### Safety channel ▲ key

Your GX400 has a dedicated Safety channel ▲ key to allow instant access to Channel 88. Pressing this key cancels all other functions such as Scan or Dual Watch and takes you straight to Channel 88. When Channel 88 is selected using the ▲ key, 'SAFETY' is displayed on the LCD.

To return to normal channel operations briefly press the ▲ key again. 'SAFETY' will disappear from the display, the radio will return to the previously selected channel. Alternatively press the ▲ or ▼ keys to select a different channel.

## DUAL WATCH (MARINE MODE)

---

Dual Watch in the Marine mode allows your GX400 to monitor both Channel 88 and another selected channel by quickly switching between them. Any signals received on Channel 88 take precedence over signals on the selected channel.



To use the Dual Watch feature, adjust the **Squelch** control so the radio is quiet, select your preferred working or club channel then press the **DW** key. 'DW' will appear on the display and the channel display will alternate between Channel 88 and your selected channel.

If a signal is received on your selected channel, the radio will pause on that channel but will continue to switch to Channel 88 and a brief interruption to the signal will be noticed. Once the signal has gone, normal Dual Watch switching will resume.

If a signal appears on Channel 88 at any time, the radio will stop switching and will remain on Channel 88 for as long as the signal is present. Once the signal has gone, normal Dual Watch switching will resume.

---

**NOTE:** If you press the **PTT** switch while Dual Watch is selected, your GX400 will transmit on the selected channel. If you wish to talk on Channel 88, press the **△** key to cancel the Dual Watch and switch straight to Channel 88.

---

## TRIPLE WATCH (MARINE MODE)

---

The Triple Watch function is an extension of the Dual Watch feature. It allows the GX400 to monitor three channels – Channel 88, the selected channel and a Priority channel. Each channel is scanned equally for signals with priority given first to Channel 88, then the Priority channel and lastly the selected channel.

When Triple Watch is selected, the 'TW' icon is displayed. The Priority channel used is the one stored in the PR1 memory.

To use the Triple Watch mode, first program your Priority channel into the PR1 memory then select your preferred working channel using the **▲** or **▼** keys. Now briefly press the **TW** key. A high beep will be heard, 'TW' will appear and the channel display will alternate between Channel 88, your selected channel and your Priority channel.

### To cancel Triple Watch

Briefly press the **TW** key. A low beep will be heard and 'TW' will disappear from the display.

## TRIPLE WATCH FEATURES

---

### If a signal appears on Channel 88

The radio will switch immediately to Channel 88 and '88' will be displayed. At this point the selected channel and the PR1 channel are no longer being monitored because Channel 88 has highest priority. During this time the **PTT** may be pressed for normal transmissions on Channel 88.

Once Channel 88 has become inactive for 2 seconds the Triple Watch function will resume.

### If a signal appears on the PR1 channel

Scanning will pause on the PR1 channel **but** Channel 88 will continue to be monitored every 2 seconds (the selected channel is not monitored). During this time the **PTT** may be pressed for normal transmissions on the PR1 channel (monitoring of Channel 88 ceases while transmitting).

Once the PR1 channel has become inactive for 2 seconds Triple Watch will resume.

### If a signal appears on the selected channel

Scanning will pause on the selected channel **but** Channel 88 **and** the PR1 channel will continue to be monitored every 2 seconds. During this time the **PTT** may be pressed for normal transmissions on the selected channel (monitoring of Channel 88 and the Priority channel ceases).

while transmitting). Once the selected channel has become inactive for 2 seconds the Triple Watch will resume.

### **To transmit on the selected channel while Triple Watching**

Simply press the **PTT**. The Triple Watch function will pause during the transmission and remain paused until 2 seconds after all activity has ceased on the channel. Triple Watch will then resume.

### **To transmit on the Priority channel while Triple Watching**

Briefly press the **PR1** key. The PR1 channel will then become the selected channel. Now press the **PTT** and transmit in the usual way. When your conversation has ended you may use the ▲ or ▼ keys to re-select your preferred channel.

### **To transmit on Channel 88 while Triple Watching**

Press the ▲ button. Triple watch will be cancelled and the radio will switch straight to Channel 88 (and 'SAFETY' will be displayed). Now press the **PTT** and transmit in the usual way. When your conversation has ended, press the ▲ button to deactivate the SAFETY channel and press the **TW** key to resume Triple Watching.

## **MARINE BAND PROCEDURES**

---

Most calls to other vessels or stations are initiated on Channel 88. After listening to ensure Channel 88 is clear, call the other station as follows, repeating both call signs three times.

e.g. "Coast Guard, Coast Guard, Coast Guard. This is – Sea Spray, Sea Spray, Sea Spray, Over"

Once contact has been established, move straight to another channel (e.g. 91 or 94) to continue your conversation, leaving Channel 88 clear for emergencies or further calls. Don't forget to return to Channel 88 when you have finished (or select Dual Watch on your radio) otherwise you may miss other calls meant for you.

## **EMERGENCY PROCEDURES**

---

All emergency calls should be made on Channel 88. There are three main types of emergency call.

### **1. "MAYDAY, MAYDAY, MAYDAY"**

This call should be used when you are in grave or imminent danger and require immediate assistance. You should call MAYDAY three times followed by your vessel's name or call sign three times. Then state your position, a brief description of your vessel, the nature of the emergency, the number of people on board and their condition. If you hear no reply, repeat the call at short intervals because someone may be able to hear you but you might not be able to receive their reply.

After contact has been made, follow any instructions given to you.

### **2. "PAN, PAN, PAN"**

Use this call when an emergency situation exists but there is no immediate danger. The call should be made in the same way as the MAYDAY call. If you hear no reply, repeat the call at regular intervals.

### **3. "SECURITE, SECURITE, SECURITE" (Pronounced Say-cure-e-tay)**



This call is used to warn shipping of dangers or hazards, e.g. Bad weather, container adrift etc. The call may be made to a local monitoring station or to all ships in the area.

## MARINE CHANNEL ASSIGNMENTS TABLE

Channel	Frequency	Use
68	27.680	Commercial, ship-shore-ship
72	27.720	Professional shipping
82	27.820	Professional shipping
86	27.860	Secondary distress and safety
88	27.880	Primary distress and safety
90	27.900	Domestic ship-shore-ship
91	27.910	Domestic ship-shore-ship
94	27.940	Club events, ship-shore-ship
96	27.960	Ship to ship
98	27.980	Rescue organisations

## OPERATION ON THE CB BAND



### Key (CB Mode)

In CB mode, the  key is preset to Road Channel 8 allowing it to be instantly recalled at the press of a key. Simply press the  key at any time. The radio will jump straight to the Road Channel 8. If Scan or DW was selected, they will be cancelled.

To return to the previously selected channel, press the  key again.

### DUAL WATCH (CB MODE)

Dual Watch in CB mode allows your GX400 to monitor both Channel 8 and another selected channel by quickly switching between them. Any signals received on Channel 8 take precedence over signals on the selected channel.

To use the Dual Watch feature, adjust the squelch control so the radio is quiet, select your preferred channel using the  or  keys then press the **DW** key. 'DW' will appear on the display and the channel display will alternate between your selected channel and Channel 8.

If a signal is received on your selected channel, the radio will pause on that channel but will continue to switch to Channel 8 and a brief interruption to the signal will be noticed. Once the signal has gone, normal Dual Watch switching will resume.

If a signal appears on Channel 8 at any time, the radio will stop switching and will remain on Channel 8 for as long as the signal is present. Once the signal has gone, normal Dual Watch will resume.

**NOTE:** If you press the **PTT** while Dual Watch is active, your GX400 will transmit on the selected channel. If you wish to talk on Channel 8, press the  key to cancel the Dual Watch and switch straight to Channel 8.

## TRIPLE WATCH (CB MODE)

---

The Triple Watch function is an extension of the Dual Watch feature. It allows the GX400 to monitor three channels – Channel 8, a selected channel and a Priority channel. Each channel is scanned equally for signals with priority given first to Channel 8, then the Priority channel and lastly the selected channel.

When Triple Watch is selected, the 'TW' icon is displayed. The Priority channel used is the one stored in the PR1 memory.

To use the Triple Watch mode, first program your Priority channel into the PR1 memory then select your preferred working channel using the ▲ or ▼ keys. Now briefly press the **TW** key. A high beep will be heard, 'TW' will appear and the channel display will alternate between Channel 8, your selected channel and your Priority channel.

### To cancel Triple Watch

Briefly press the **TW** key. A low beep will be heard and 'TW' will disappear from the display.

## TRIPLE WATCH FEATURES

---

### If a signal appears on Channel 8

The radio will switch immediately to Channel 8. At this point the selected channel and the PR1 channel are no longer being monitored because Channel 8 has highest priority. During this time the **PTT** may be pressed for normal transmissions on Channel 8.

Once Channel 8 has become inactive for 2 seconds the Triple Watch function will resume.

### If a signal appears on the PR1 channel

Scanning will pause on the PR1 channel **but** Channel 8 will continue to be monitored (the selected channel is not monitored). During this time the **PTT** may be pressed for normal transmissions on the PR1 channel (monitoring of Channel 8 ceases while transmitting).

Once the PR1 channel has become inactive for 2 seconds Triple Watch will resume.

### If a signal appears on the selected channel

Scanning will pause on the selected channel **but** Channel 8 **and** the PR1 channel will continue to be monitored. During this time the **PTT** may be pressed for normal transmissions on the selected channel (monitoring of Channel 8 and the Priority channel ceases while transmitting). Once the selected channel has become inactive for 2 seconds the Triple Watch will resume.

### To transmit on the selected channel while Triple Watching

Simply press the **PTT**. The Triple Watch function will pause during the transmission and remain paused until 2 seconds after all activity has ceased on the channel. Triple Watch will then resume.

### To transmit on the Priority channel while Triple Watching

Briefly press the **PR1** key. The PR1 channel will then become the selected channel. Now press the **PTT** and transmit in the usual way. When your conversation has ended you may use the ▲ or ▼ keys to re-select your preferred channel.

## To transmit on Channel 8 while Triple Watching

Press the **△** button. Triple watch will be cancelled and the radio will switch straight to Channel 8 (and 'SAFETY' will be displayed). Now press the **PTT** and transmit in the usual way. When your conversation has ended, press the **△** button to deactivate the SAFETY channel then press the **TW** key to resume Triple Watching.

27 MHz CHANNEL ASSIGNMENTS					
Channel	Frequency	Suggested Usage	Channel	Frequency	Suggested Usage
1	26.965 MHz	General AM	21	27.215 MHz	General Use
2	26.975 MHz	General AM	22	27.225 MHz	General Use
3	26.985 MHz	General AM	23	27.255 MHz	General Use
4	27.005 MHz	General AM	24	27.235 MHz	General Use
5	27.015 MHz	General AM	25	27.245 MHz	General Use
6	27.025 MHz	General AM	26	27.265 MHz	General Use
7	27.035 MHz	General AM	27	27.275 MHz	General Use
8	27.055 MHz	General AM (2)	28	27.285 MHz	General Use
9	27.065 MHz	Emergency (1)	29	27.295 MHz	General Use
10	27.075 MHz	General AM	30	27.305 MHz	General Use
11	27.085 MHz	Call Channel	31	27.315 MHz	General Use
12	27.105 MHz	General AM	32	27.325 MHz	General Use
13	27.115 MHz	General AM	33	27.335 MHz	General Use
14	27.125 MHz	General AM	34	27.345 MHz	General Use
15	27.135 MHz	General AM	35	27.355 MHz	General Use
16	27.155 MHz	General Use	36	27.365 MHz	General Use
17	27.165 MHz	General Use	37	27.375 MHz	General Use
18	27.175 MHz	General Use	38	27.385 MHz	General Use
19	27.185 MHz	General Use	39	27.395 MHz	General Use
20	27.205 MHz	General Use	40	27.405 MHz	General Use

(1) Legally Designated

(2) Suggested Road Channel

## GENERAL

It is advisable to spend a little time selecting the best location for your GX400. The radio can be mounted to a shelf or panel using the supplied gimbal bracket. Alternatively it can be flush mounted using an optional flush mount kit.

### Keep the following points in mind when choosing a location

- The GX400 is designed to meet IPX7 standard. However we recommended you select a location that will minimise excessive exposure to continuous rain or spray.
- Select a location that won't expose your radio to continuous direct sunlight which could cause overheating.
- Ensure the location allows a free flow of air around the heat sink on the back of the radio.
- The microphone and all controls should be readily accessible and the loud speaker easily heard from the normal steering or driving position. An extension speaker can be installed if required.
- Components and currents in the radio create magnetic fields. To avoid interference to compasses, ships autopilot sensors etc, the GX400 should be mounted at least 30 cm from such devices.

## INSTALLING THE UNIT

### Gimbal Mounting

The mounting bracket can be rotated above, below or behind the radio enabling the radio to be mounted to a wide range of locations.

After choosing a location, hold the unit with the mounting bracket attached, to the desired position and mark the location with a pencil. Remove the mounting bracket from the radio and drill the mounting holes. Bolt or screw the bracket in place using hardware suitable for the mounting surface. The unit is supplied with stainless steel screws; however, if the mounting surface is unsuitable for screws you may need to replace these with stainless steel bolts.

Remember the fixings for overhead mounted units may have to withstand heavy pounding when a vessel is in rough water or being towed on a trailer over rough road.

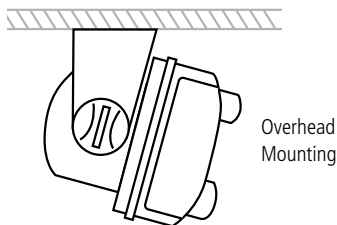
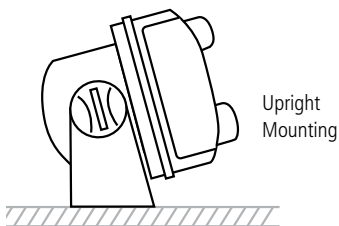

## Flush Mounting

The GX400 can be flush mounted using the optional MK008 flush mounting kit. A cutting template and full mounting instructions are provided with the kit.

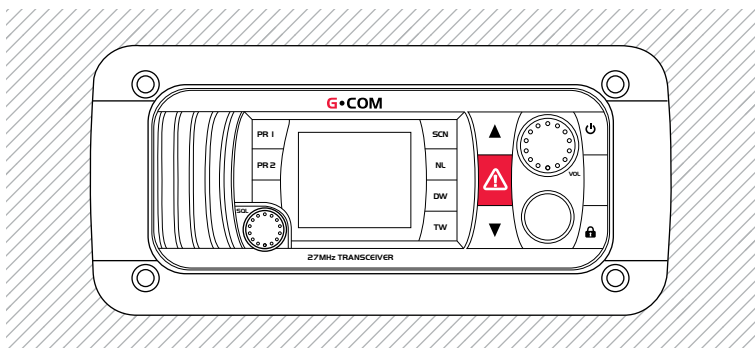

Flush Mounting using the optional MK008 mounting kit

## DC CONNECTIONS

Connect the **RED** power lead to the Positive (+) side of the battery or to an accessory point in the vessel or vehicle's fuse box.

Connect the **BLACK** power lead to the Negative (-) side of the battery or to a ground point in your vessel or vehicle.

**IMPORTANT:** The RED power lead is fitted with a 2 Amp fuse. If the fuse blows, use only a standard 2 Amp (3AG) fuse as a replacement. Use of a higher rated fuse or a slow-blow type could result in damage to your radio which would void the warranty.

If required, an extension speaker may be installed to improve sound levels in noisy environments or in locations further away from the steering or driving position.

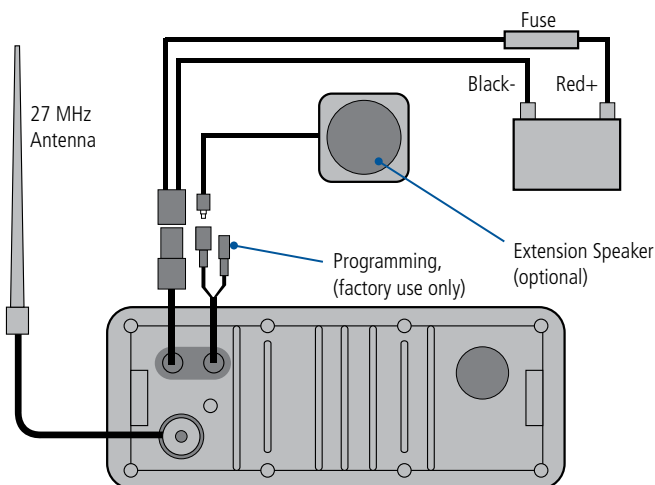

## ANTENNA INSTALLATION

---

It is essential to select a good quality, high efficiency, 27 MHz antenna. A poor quality antenna or one not designed for the specific frequency band you are using will give very poor performance.

Since the GX400 is capable of being switched between the 27 MHz Marine and the 27 MHz CB Bands, it is important to connect an antenna suitable for the band you have chosen to use. Because each band is in a different part of the frequency spectrum it isn't possible to have a single antenna that will work well on both bands. You will therefore need to select a suitable antenna to suit the band you have selected.

GME have a huge range of suitable 27 MHz CB and 27 MHz marine antennas to suit most installations and applications. We recommend you contact your local dealer for advice.

Connect the antenna cable to the rear antenna socket using a PL259 coaxial connector.

.....  
**NOTE:** The antenna connector is not waterproof.  
.....

## EXTENSION SPEAKER

---

If required an optional 8 Ohm extension speaker can be fitted to the GX400 to extend the sound to another part of your vessel (e.g. If the radio is mounted inside the cabin, the extension speaker can be used to monitor incoming calls while outside). When the extension speaker is plugged in, the internal speaker continues to operate allowing you to hear sound at both locations.

Plug the extension speaker into the 3.5 mm socket on the rear cable.

## NOISE SUPPRESSION

---

27 MHz AM marine and CB radio systems can be prone to electrical and ignition interference. The reason is that electrical noise is a form of AM transmission similar to that used by your radio and your radio's receiver is very sensitive. In most cases, ignition noise can be greatly reduced or eliminated by selecting the **Noise Limiter (NL)** key on the radio. In some severe cases, additional suppression may need to be fitted to the ignition system of your vessel or vehicle, in which case we recommend you consult an auto or marine electrician for advice specific to your installation.

Higher frequency electrical interference caused by electric motors and bilge pumps can be suppressed directly at the motor terminals. Electronic interference caused by other electronic devices such as fish finders is best minimised by keeping the units, including all wiring and cables, separate from your GX400.



## DISCONNECTING THE MICROPHONE

---

It is recommended that the microphone be left permanently connected to the GX400, but if it must be disconnected, proceed as follows:

1. Using a small screwdriver, ease the rubber boot out of the cable entry hole and slide it along the microphone cable away from the front panel.
2. Identify the plug locking lever, work the screwdriver blade behind it and press the lever towards the plug body. At the same time gently pull the plug from the socket (see diagram below).

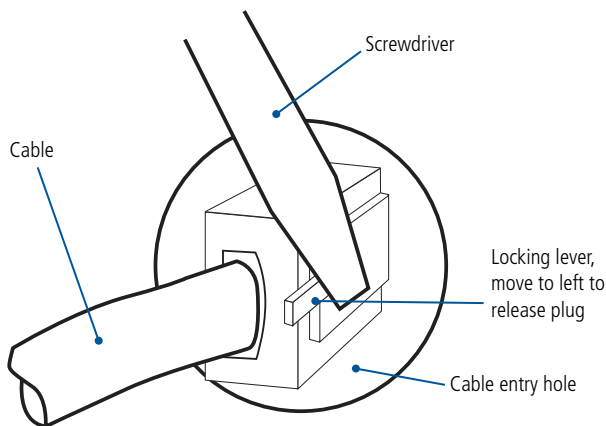

---

**NOTE:** If required, replacement microphones are available with plug and rubber boot already fitted.

---

## SPECIFICATIONS\*

### GENERAL

---

Complies with:	AS4367:2007
Frequency Range:	26 – 30 MHz
Channel Set:	Australian 27 MHz CB (26.965 – 27.405 MHz) Australian Marine (27.680 – 27.980 MHz)
Modulation:	AM (A3E)
Supply Voltage:	• 12 V DC nominal • 10.8 – 15.6 V DC range
Frequency Error:	±1.4 kHz
Dual Watch:	Monitor time – 250 ms
Scan Rate:	5 channels/second

### TRANSMITTER

---

Max Modulation Depth:	100%
Carrier Output Power:	4 watts max
Spurious Emissions:	< – 26 dBm

### RECEIVER

---

Receive Sensitivity for 12 dB SINAD @ 30% Modulation:	– 110 dBm
Max Squelch:	< – 65 dBm
Adjacent Channel Selectivity:	≥ 55 dB
Spurious Response Immunity:	≥ 55 dB
Conducted Spurious Radiation	≤ – 57 dBm
Audio Output Power 8 Ohms:	2.5 watts

### MECHANICAL

---

Dimensions:	65 (H) x 75 (D) x 164 (W) mm
Weight:	602 grams

### ENVIRONMENTAL

---

Temperature Range:	– 0°C to + 55°C
--------------------	-----------------

The GX400 will operate over the 26 – 30 MHz frequency range. For information specific to frequencies outside of the Australian Marine or the Australian and New Zealand CB bands, please refer to the appropriate amendment, or contact GME at: [export@gme.net.au](mailto:export@gme.net.au)

\*All specifications are typical and subject to change without notice or obligation.

## STANDARD COMMUNICATIONS WARRANTY AGAINST DEFECTS

This warranty against defects is given by Standard Communications Pty Ltd ACN 000 346 814 (We, us, our or GME). Our contact details are set out in clause 2.7. This warranty statement only applies to products purchased in Australia. Please contact your local GME distributor for products sold outside of Australia. Local distributor details at: [www.gme.net.au/export](http://www.gme.net.au/export).

### 1. Consumer guarantees

- 1.1 Our goods come with guarantees that cannot be excluded under the Australian Consumer Law. You are entitled to a replacement or refund for a major failure and for compensation for any other reasonably foreseeable loss or damage. You are also entitled to have the goods repaired or replaced if the goods fail to be of acceptable quality and the failure does not amount to a major failure.
- 1.2 To the extent we are able, we exclude all other conditions, warranties and obligations which would otherwise be implied.

### 2. Warranty against defects

- 2.1 This warranty is in addition to and does not limit, exclude or restrict your rights under the Competition and Consumer Act 2010 (Australia) or any other mandatory protection laws that may apply.
- 2.2 We warrant our goods to be free from defects in materials and workmanship for the warranty period (see warranty table) from the date of original sale (or another period we agree to in writing). Subject to our obligations under clause 1.2, we will at our option, either repair or replace goods which we are satisfied are defective. We warrant any replacement parts for the remainder of the period of warranty for the goods into which they are incorporated.
- 2.3 To the extent permitted by law, our sole liability for breach of a condition, warranty or other obligation implied by law is limited.
  - (a) In the case of goods we supply, to any one of the following as we decide –
    - (i) The replacement of the goods or the supply of equivalent goods.
    - (ii) The repair of the goods.
    - (iii) The cost of repairing the goods or of acquiring equivalent goods.
  - (b) In the case of services we supply, to any one of the following as we decide –
    - (i) The supplying of the services again
    - (ii) The cost of having the services supplied again.

- 2.4 For repairs outside the warranty period, we warrant our repairs to be free from defects in materials and workmanship for three months from the date of the original repair. We agree to re-repair or replace (at our option) any materials or workmanship which we are satisfied are defective.
- 2.5 We warrant that we will perform services with reasonable care and skill and agree to investigate any complaint regarding our services made in good faith. If we are satisfied that the complaint is justified, and as our sole liability to you under this warranty (to the extent permitted at law), we agree to supply those services again at no extra charge to you.
- 2.6 To make a warranty claim you must before the end of the applicable warranty period (see warranty table), at your own cost, return the goods you allege are defective, provide written details of the defect, and give us an original or copy of the sales invoice or some other evidence showing details of the transaction.
- 2.7 Send your claim to:  
Standard Communications Pty Ltd.  
17 Gibbon Rd, Winston Hills, NSW 2153, Australia.  
Tel: (02) 8867 6000 Fax: (02) 8867 6199.  
Email: [servadmin@gme.net.au](mailto:servadmin@gme.net.au)
- 2.8 If we determine that your goods are defective, we will pay for the cost of returning the repaired or replaced goods to you, and reimburse you for your reasonable expenses of sending your warranty claim to us.



### 3. What this warranty does not cover

- 3.1 This warranty will not apply in relation to:
  - (a) Goods modified or altered in any way.
  - (b) Defects and damage caused by use with non Standard Communications products.
  - (c) Repairs performed other than by our authorised representative.
  - (d) Defects or damage resulting from misuse, accident, impact or neglect.
  - (e) Goods improperly installed or used in a manner contrary to the relevant instruction manual; or
  - (f) Goods where the serial number has been removed or made illegal.

### 4. Warranty period

- 4.1 We provide the following warranty on GME and Kingray products. No repair or replacement during the warranty period will renew or extend the warranty period past the period from original date of purchase.

PRODUCT TYPE	WARRANTY PERIOD
27 MHz land and marine radios	1 year

 **1300 463 463**  **[gme.net.au](http://gme.net.au)**

A division of Standard Communications Pty Ltd.

Head Office: PO Box 96, Winston Hills, NSW 2153, Australia.

New Zealand: PO Box 58446 Botany, Auckland, 2163, NZ. T: (09) 274 0955.

All international enquiries email: [export@gme.net.au](mailto:export@gme.net.au)